

PFD

PFD-P250VM-E
PFD-P500VM-E
PUHY-P250YJM-A(-BS)
PUHY-P500YSJM-A(-BS)
PQHY-P250YHM-A

REAM
d.o.o.

*Ream d.o.o., Špruha 19, 1236 IOC Trzin
t. +386 1 563 70 57, f. +386 1 562 24 14
info@ream.si, www.ream.si*

KLIMATSKE NAPRAVE IN SISTEMI



CLOSE CONTROL SYSTEM

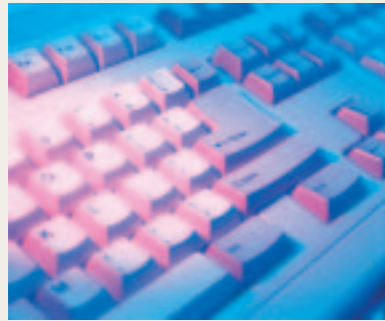

MITSUBISHI ELECTRIC's Close Control System (PFD series) is specifically designed for computer rooms, laboratories etc, where strict control of humidity and temperature is a must. It possesses "High Reliability", "Energy Saving Technology", and "Easy Installation / Maintenance". It can be connected to a computer network using our AG-150A controller, in order to monitor from a distance and provide remote email alarms.



High Reliability

Precise Room Temperature Control

PFD series maintain a nearly constant room temperature (within $\pm 1.0^{\circ}\text{C}$) without the typical temperature changes that occur with conventional ON/OFF control systems with inverter driven compressor.

* Depending on the loading conditions

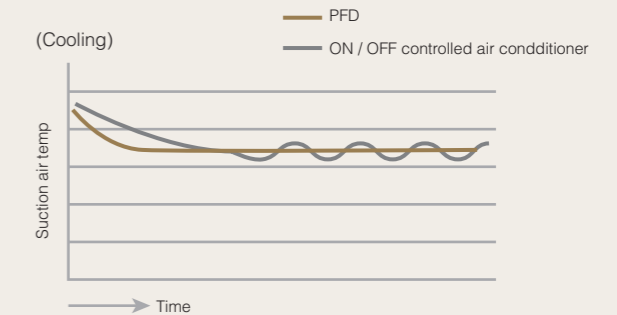

Quick Recovery from Power Failure

After an initial setting of outdoor unit is completed within 20 seconds of power recovery, thermo ON signal will turn on and it will take 5 seconds for an outdoor unit fan and compressor operation to start. PFD unit will restart within 20 seconds+(indoor unit address/2). To prevent the inrush current when recovering from power failure, the indoor unit system will restart one by one.

(example)

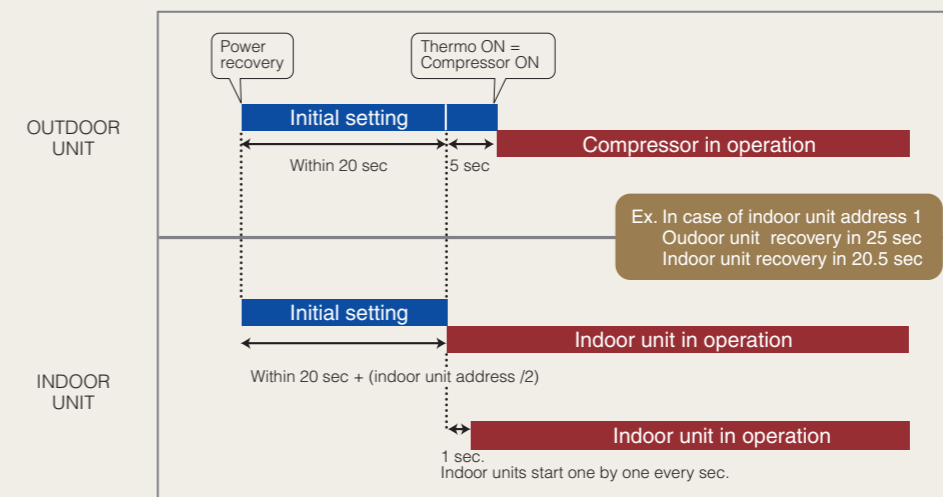

Protection of Confidential Information

As a compressor has been incorporated into the outdoor unit, the compressor can be serviced without entering a computer room. Our close control system can protect confidential information.

NEW PFD System Rotation

One unit in a system will alternatively be in stand-by position as a back-up unit in case of malfunction.

PFD series provide you with highly reliable computer room cooling system

CLOSE CONTROL SYSTEM

Energy Saving Technology

Low Running Cost

The inverter driven compressors can maximize the energy efficiency of PFD series, leading to reduction of power consumption.

PFD series coefficient of performance (COP) are over 3.00 in cooling mode.

[Sensible heat factor (SHF) : 0.93]

Low Power Consumption

Plus, new PFD series adopt advanced R410A refrigeration and control technology to offer lower power consumption.

Inverter-driven capacity control

□ 10HP Outdoor Unit

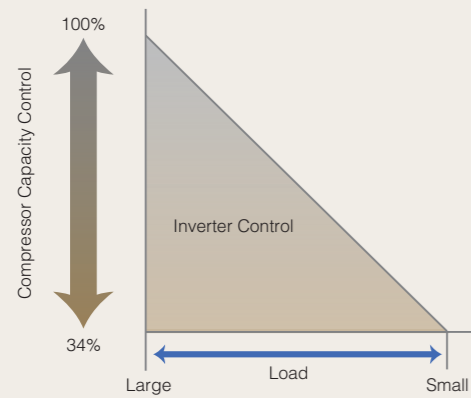

□ 20HP Outdoor Unit

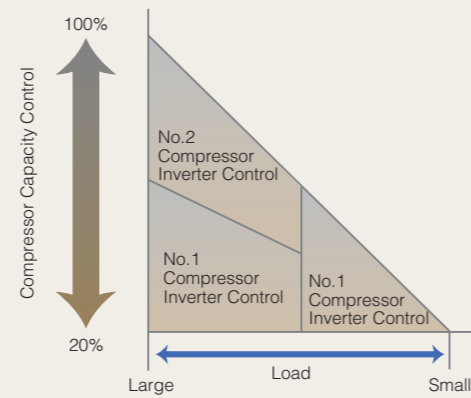

PFD series operates highly efficiently with using newly developed inverter compressor

Energy Saving Technology

Minimum Humidifiers

PFD series work without a large capacity humidifier in most specifications. Due to the use of an optimized inverter driven compressor, PFD series minimize the excessive dehumidification whereas other systems need a separate humidifier for each indoor unit.

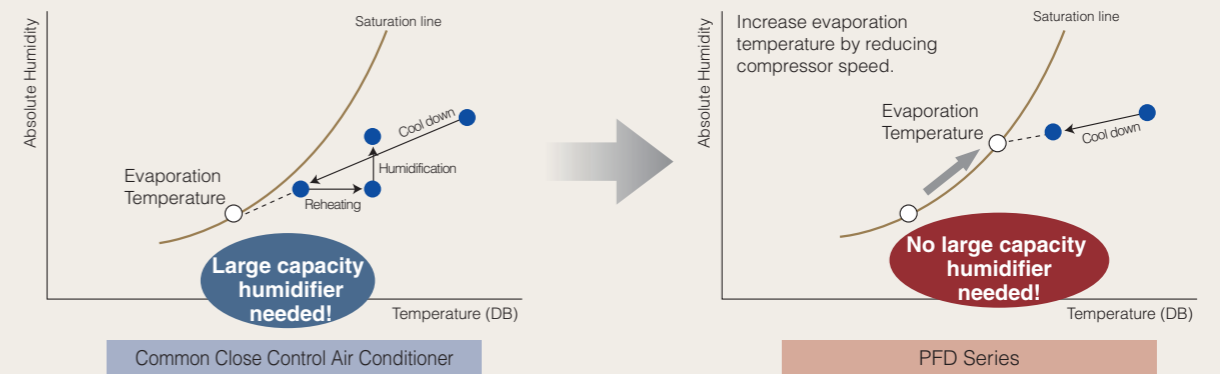

This system will also help to minimize maintenance costs by removing the need for a large capacity humidifier.

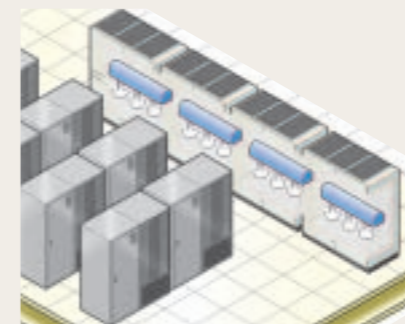

Common Close Control Air Conditioner



PFD Series

* A humidifier can be incorporated inside of the units. Consult our sales office in your area for more detailed information.

PFD series will not have excessive dehumidification

Easy Installation/Maintenance

Small Installation Space

PFD series are specifically designed to minimize the size of the indoor units and save on valuable computer room space.

Service Space (Indoor)

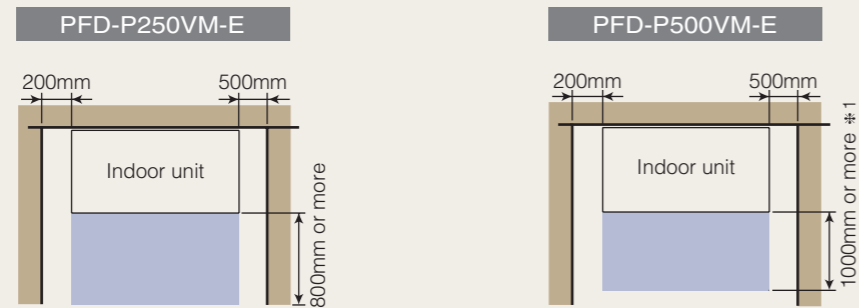

※1. It is necessary for the removal of the panel beyond 600mm.

Piping length

With long pipe-runs of up to 165m, top-bottom differentials of 50m (40m if the outdoor unit is installed below indoor unit, 15m if the outdoor temperature is under 10°C), flexible design is available with both air and water cooled outdoor unit.

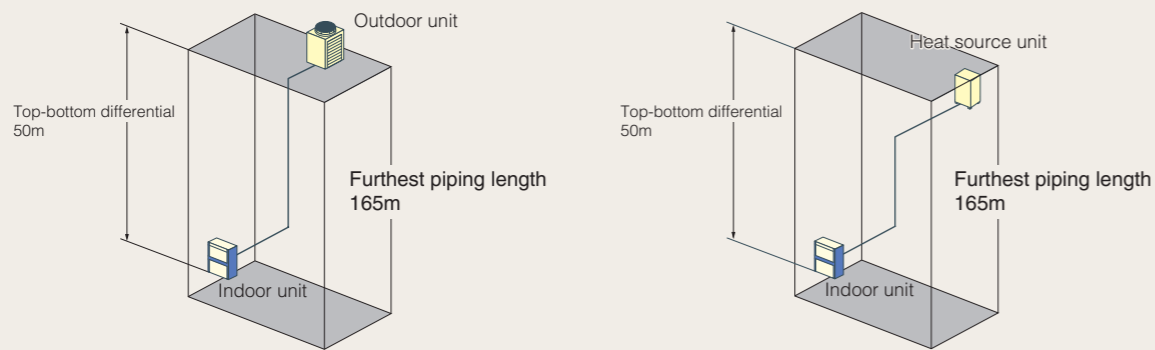

※ Same length with two refrigerant circuit connection

Unit Combination

PFD + Air cooled outdoor unit

When connecting PFD-P500VM-E and P500 outdoor unit, either 1 or 2 refrigerant circuit connection is available depending on system size and usage. With 2 refrigerant circuit connection, one circuit can back up the other.

If installation and large number of units are to be installed, single refrigerant circuit can be selected.

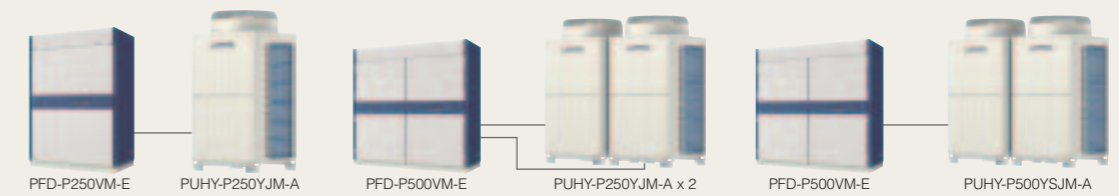

※ At factory shipment, this model of indoor unit is designed and set to accommodate a single refrigerant circuit. Connection of two refrigerant circuits to the indoor unit requires setting change and pipe work.

PFD + Water cooled outdoor unit

When connecting PFD-P500VM-E unit and water cooled outdoor unit, only 2 refrigerant circuit connection is available and single refrigerant connection is not available.



※ Single refrigerant circuit connection is not available with water-cooled unit.

Operation Zone

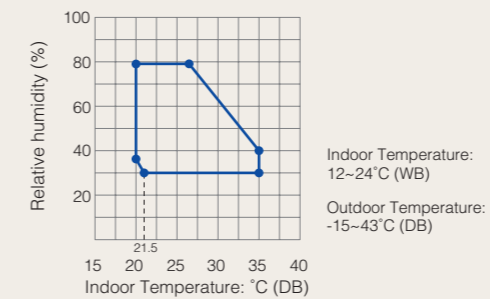

PFD series will be able to satisfy various installation conditions

OUTDOOR UNIT

AIR COOLED OUTDOOR UNIT



Outdoor Unit

High-capacity reluctance DC motor driven compressor

Motor efficiency greatly improved

+

Reduced suction refrigerant heating loss



First in Industry
Japan Machinery Federation
Executive Award-winning

Low Noise in All Directions

(10HP)

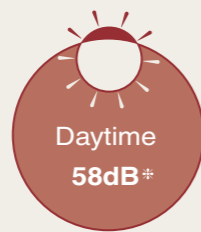

* Measured in anechoic room

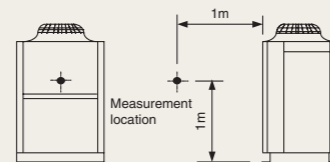

Low noise mode can reduce sound level by sensing ambient temperature condition.
(This function is available in setting at site.)

PFD series are made in Japan under a stringent quality control system of Mitsubishi Electric.

WATER COOLED HEAT SOURCE UNIT



Heat source Unit

Cold climate capability

Because the system is water cooled, the outdoor air temperature does not affect capacity. Furthermore, water cooling means no defrost operation is required, so rapid starting assures quick and continuous cooling in the hottest conditions.

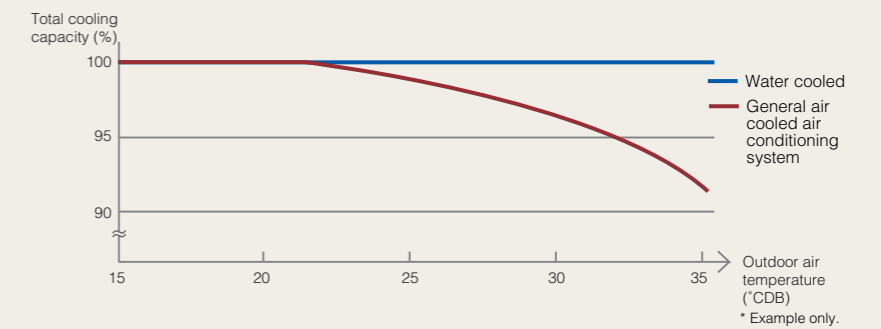

Heat recovery

When used in combination with the City Multi WR2 series, Heat recovery between Heat Source Units is possible.

Example of water cooled system diagram ▶

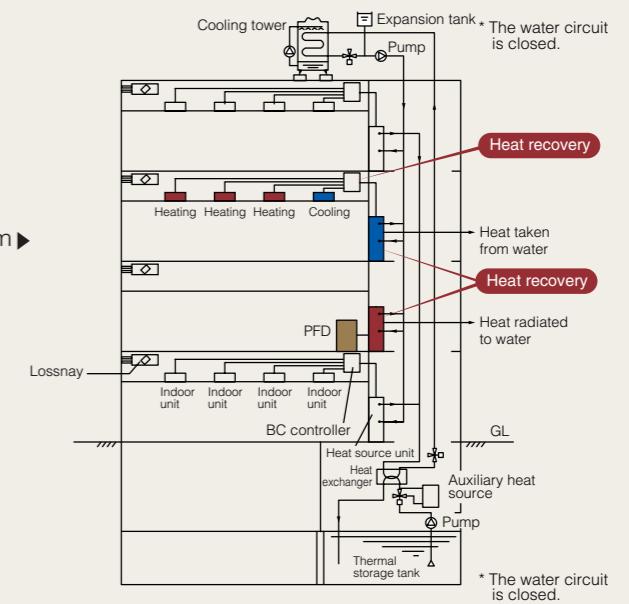

Water cooled PFD series offers reliability and energy-saving that computer rooms require.

CONTROL

Remote Controller

Embedded MA remote controller and display lamps on the PFD unit enables easy control and operation.

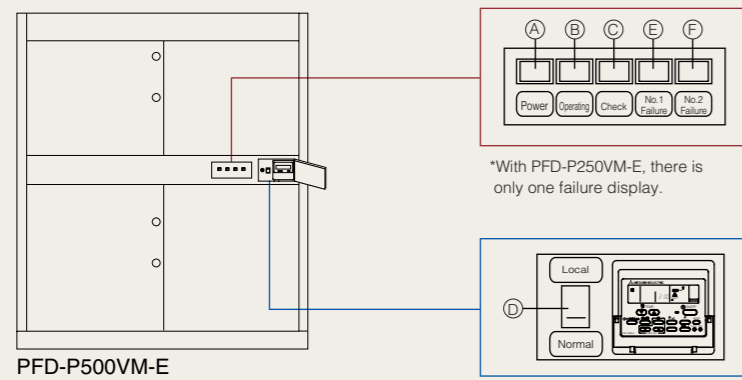

- Ⓐ Power display lamp
 - Ⓑ Operation display lamp
 - Ⓒ Check display lamp
 - Ⓓ Normal / Local switch
 - Ⓔ No.1 Failure display lamp
 - Ⓕ No.2 Failure display lamp
- * When Local operation is available at maintenance, please set "Normal / Local" switch to "Local". Then "Check" lamp will be lit.

Centralized Controller

With a new colored touch panel, and continuation of all the conventional G-50A functions, AG-150A visualizes its functions from basic control to advanced operations and bringing an ultimate controller to reality.



Centralized controller AG-150A

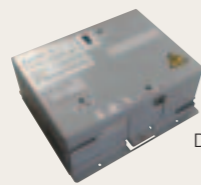

Expansion Controller PAC-YG50ECA
Dimensions: 250(W) x 217(H) x 97.2(D) mm
: 9-7/8(W) x 8-9/16(H) x 3-7/8(D) in.



Option : Black surface cover
PAC-YG71CB

With a connection of a Expansion Controller, maximum of 150 units/groups can be connected to AG-150A.

New Design

Backlight Color liquid crystal display

Backlight makes it easy to see and control units. One can identify whether a unit is ON or OFF from a distance. Control in the night with no lights is possible.

Touch panel

9 inch wide, high-resolution Touch panel enables operation of units by touching with index finger. When object unit is touched, orange box appears around the unit icon indicating the unit selected.

USB memory compatible

All measurement/initial setting CSV data extractable with USB memory. Can save and overwrite setting data.

New Functions

Controllable units/groups

Controls up to 50 units/groups (including indoor units, LOSSNAY, DIDO/AI/PI controller) Up to 150 units can be controlled via expansion controller; PAC-YG50ECA (AG-150A software needs to be upgraded)

Monitoring functions

Temperature/Humidity (using AI controller with WEB browser) *1
General equipment such as lights on LCD (using DIDO controller)
Interlock function from AI controller, DIDO controller to indoor units and between DIDO units are available. AG-150A interlock with DIDO controller or free contact on an indoor unit available. *Ver. 2.30 or later

Energy saving functions

Seasonal scheduling and automatic switch over *1
Yearly scheduling on LCD *1
*1 License required.

System structure

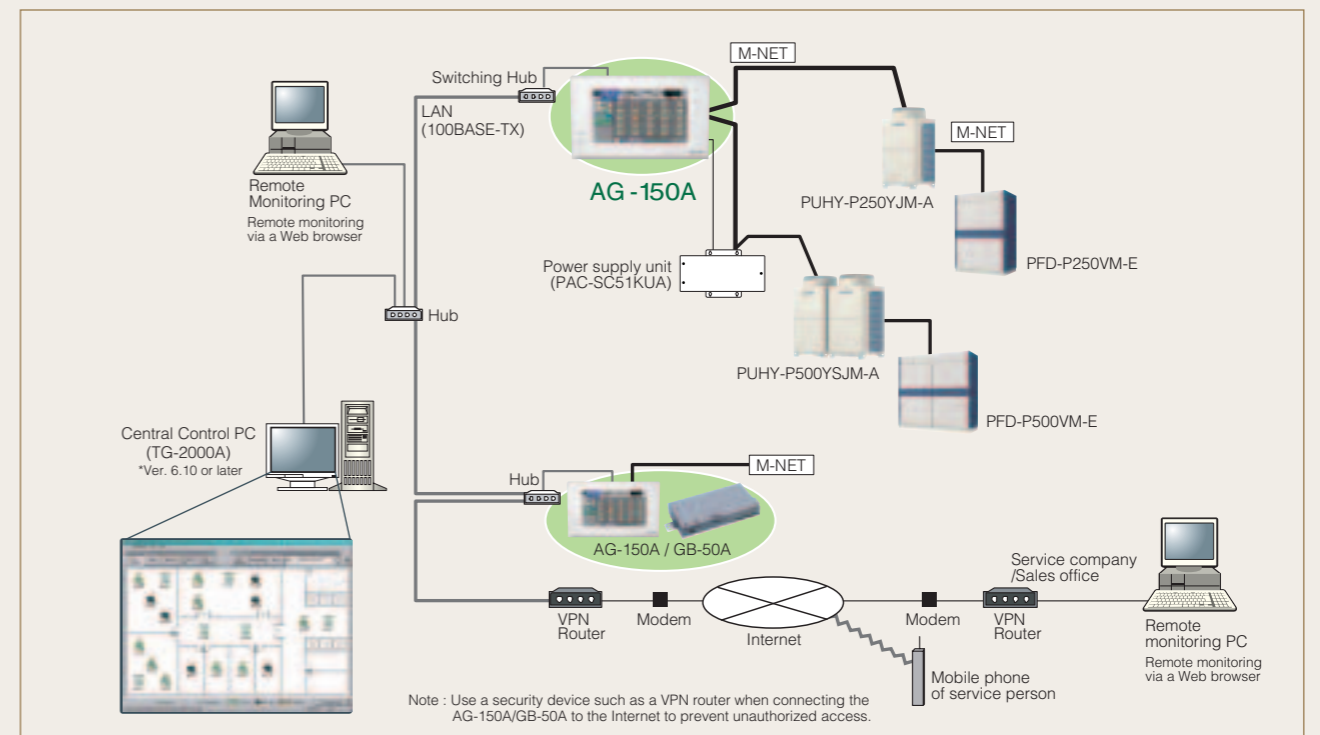

Indoor Unit

PFD-P250VM-E (down flow)



Specification

Model name		PFD-P250VM-E	
Capacity	kW	Cooling 28.0	Heating 31.5
	BTU/h	95,500	107,500
Sensible Heat Capacity	kW	26.0	—
	BTU/h	88,700	—
Power source		3N~380 / 400 / 415V (50Hz) , 400 / 415V (60Hz)	
Power input		2.50 kW	
Current		5.3 / 5.0 / 4.9 A	
Fan	Type X Quantity	Sirocco fan x 1	
	Airflow rate	160 m ³ /min	
	Motor output	2.2 kW	
Refrigerant		R410A	
External finish		Galvanized steel plate (with polyester coating) <MUNSEL 2.9GY 8.6 / 0.3 (White) or similar> <MUNSEL 7.2GB 3.2 / 5.3 (Blue) or similar>	
External dimension (H) x (W) x (D)		1950 x 1380 x 780 mm	
Protection device		Fan Thermal switch	
Refrigerant piping diameter		Liquid / Gas ø 9.52 Brazed (ø12.7 for over 90m) / ø 22.2 Brazed	
Sound pressure level		59 dB (A)	
Net weight		380 kg	
Operating temperature range	Indoor	12 ~ 24°C (54 ~ 75°F) W.B.	15 ~ 28°C (59 ~ 82°F) D.B.
	(Outdoor)	(-15 ~ 43°C (5 ~ 109°F) D.B.)	(-15 ~ 15.5°C (5 ~ 60°F) W.B.)
	(Water)	(10 ~ 45°C (50 ~ 113°F))	(10 ~ 45°C (50 ~ 113°F))

- Note: 1. Cooling / Heating capacity indicates the maximum value at operation under the following condition.
 <Cooling> Indoor : 27°C (81°F) DB / 19°C (66°F) WB Outdoor : 35°C (95°F) DB (Air cooled) / Water temperature 30°C (86°F) (Water cooled)
 <Heating> Indoor : 20°C (68°F) DB Outdoor : 7°C (45°F) DB / 6°C (43°F) WB (Air cooled) / Water temperature 20°C (68°F) (Water cooled)
 Pipe length : 7.5m Level difference: 0m
2. The sound pressure level is measured in an anechoic room.
 3. Heating can be used only by the indoor warming-up.
 4. Works not included : Installation / foundation work, electric connection work, duct work, insulation work,
 The power source switch and other items are not specified in the specifications.
 5. It is necessary to change pulley and v-belt when using it by the power supply frequency 60Hz.
 6. If units are operated for a long time at the relative humidity of 80% or more, condensate may collect and drip from the indoor units.

External Dimensions

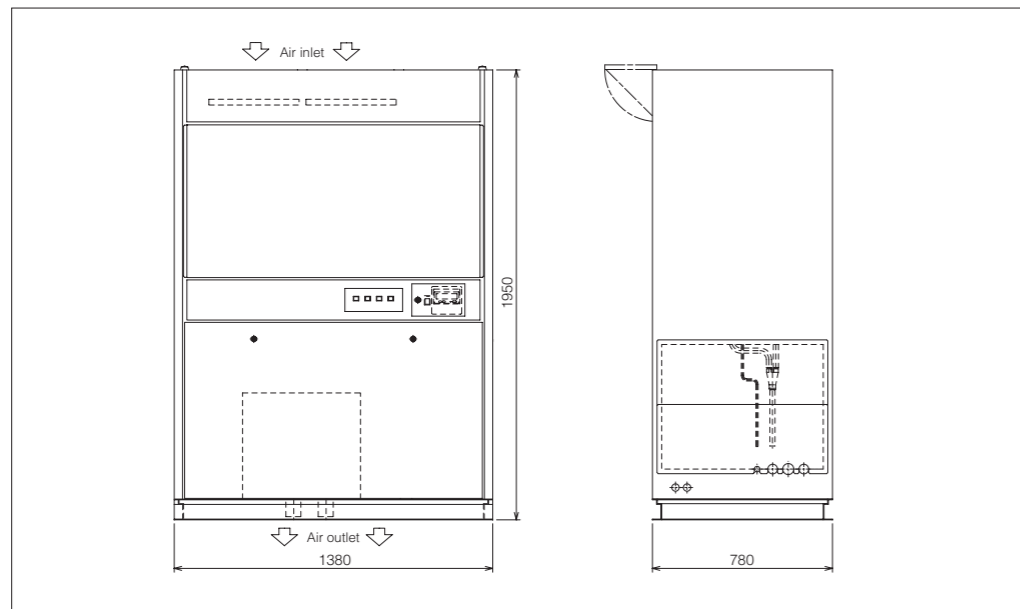

Indoor Unit

PFD-P500VM-E (down flow)



Specification

Model name		PFD-P500VM-E	
Capacity	kW	Cooling 56.0	Heating 63.0
	BTU/h	191,100	215,000
Sensible Heat Capacity	kW	52.0	—
	BTU/h	177,400	—
Power source		3N~380 / 400 / 415V (50Hz) , 400 / 415V (60Hz)	
Power input		5.00 kW	
Current		9.5 / 9.0 / 8.7 A	
Fan	Type X Quantity	Sirocco fan x 2	
	Airflow rate	320 m ³ /min	
	Motor output	4.4 kW	
Refrigerant		R410A	
External finish		Galvanized steel plate (with polyester coating) <MUNSEL 2.9GY 8.6 / 0.3 (White) or similar> <MUNSEL 7.2GB 3.2 / 5.3 (Blue) or similar>	
External dimension (H) x (W) x (D)		1950 x 1980 x 780 mm	
Protection device		Fan Thermal switch	
Refrigerant piping diameter		Liquid / Gas Single refrigerant circuit : ø 15.88 Brazed / ø 28.58 Brazed Two refrigerant circuits : ø 9.52 x 2 (ø12.7 x 2 for over 90m) Brazed / ø 22.2 x 2 Brazed	
Sound pressure level		63 dB (A)	
Net weight		520 kg	
Operating temperature range	Indoor	12 ~ 24°C (54 ~ 75°F) W.B.	15 ~ 28°C (59 ~ 82°F) D.B.
	(Outdoor)	(-15 ~ 43°C (5 ~ 109°F) D.B.)	(-15 ~ 15.5°C (5 ~ 60°F) W.B.)
	(Water)	(10 ~ 45°C (50 ~ 113°F))	(10 ~ 45°C (50 ~ 113°F))

- Note: 1. Cooling / Heating capacity indicates the maximum value at operation under the following condition.
 <Cooling> Indoor : 27°C (81°F) DB / 19°C (66°F) WB Outdoor : 35°C (95°F) DB (Air cooled) / Water temperature 30°C (86°F) (Water cooled)
 <Heating> Indoor : 20°C (68°F) DB Outdoor : 7°C (45°F) DB / 6°C (43°F) WB (Air cooled) / Water temperature 20°C (68°F) (Water cooled)
 Pipe length : 7.5m Level difference: 0m
2. The sound pressure level is measured in an anechoic room.
 3. Heating can be used only by the indoor warming-up.
 4. Works not included : Installation / foundation work, electric connection work, duct work, insulation work,
 The power source switch and other items are not specified in the specifications.
 5. It is necessary to change pulley and v-belt when using it by the power supply frequency 60Hz.
 6. If units are operated for a long time at the relative humidity of 80% or more, condensate may collect and drip from the indoor units.

External Dimensions

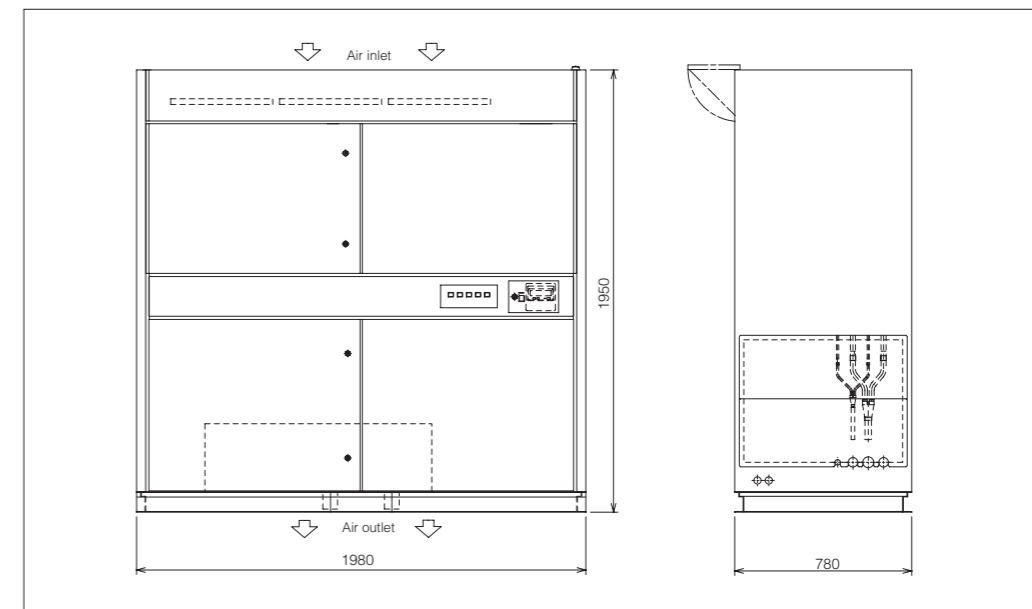

Outdoor Unit

PUHY-P250, P500Y(S)JM-A (-BS)
(connected with PFD series.)



Specification

Model name		PUHY-P250YJM-A (-BS)		PUHY-P500YSJM-A (-BS)	
		Cooling	Heating	Cooling	Heating
Capacity	kW	28.0	31.5	56.0	63.0
	BTU/h	95,500	107,500	191,100	215,000
Power source		3N~380 / 400 / 415V (50Hz / 60Hz)			
Power input	kW	6.80	6.60	13.60	13.20
Current	A	11.4 / 10.9 / 10.5	11.1 / 10.5 / 10.2	22.8 / 21.8 / 21.0	22.2 / 21.0 / 20.4
Fan	Type X Quantity	Propeller fan x 1		Propeller fan x 2	
	Airflow rate	170		170 x 2	
	Motor output	0.46 x 1		0.46 x 2	
Refrigerant		R410A			
External finish		Pre-coated galvanized steel sheets (+ powder coating for-BS type) <MUNSEL 5Y8 / 1 or similar>			
External dimension (H) x (W) x (D)	mm	1710 (without legs 1650) x 920 x 760		1710 (without legs 1650) x 920 x 760	
Protection device	High pressure protection	High pres. Sensor & High pres. Switch at 4.15 MPa (601psi)			
	Inverter circuit (COMP. / FAN)	Over-heat protection, Over-current protection			
Compressor		Over-heat protection			
	Fan motor	Thermal switch			
Refrigerant piping diameter	Liquid / Gas	ø 9.52 Brazed (ø 12.7 for over 90m) / ø 22.2 Brazed		ø 15.88 Brazed / ø 28.58 Brazed	
Sound pressure level	dB (A)	58		61	
Net weight	kg	200		200 x 2	
Operating temperature range	Outdoor	-15 ~ 43°C (5 ~ 109°F) D.B.	-15 ~ 15.5°C (5 ~ 60°F) W.B.	-15 ~ 43°C (5 ~ 109°F) D.B.	-15 ~ 15.5°C (5 ~ 60°F) W.B.
	(Indoor)	(12 ~ 24°C (54 ~ 75°F) W.B.)	(15 ~ 28°C (59 ~ 82°F) D.B.)	(12 ~ 24°C (54 ~ 75°F) W.B.)	(15 ~ 28°C (59 ~ 82°F) D.B.)

- Note: 1. Cooling / Heating capacity indicates the maximum value at operation under the following condition.
 <Cooling> Indoor : 27°C (81°F) DB / 19°C (66°F) WB Outdoor : 35°C (95°F) DB
 <Heating> Indoor : 20°C (68°F) DB Outdoor : 7°C (45°F) DB / 6°C (43°F) WB
 Pipe length : 7.5m
 Level difference: 0m
 2. The sound pressure level is measured in an anechoic room.
 3. Heating can be used only by the indoor warming-up.
 4. Works not included : Installation / foundation work, electric connection work, duct work, insulation work,
 The power source switch and other items are not specified in the specifications.

External Dimensions

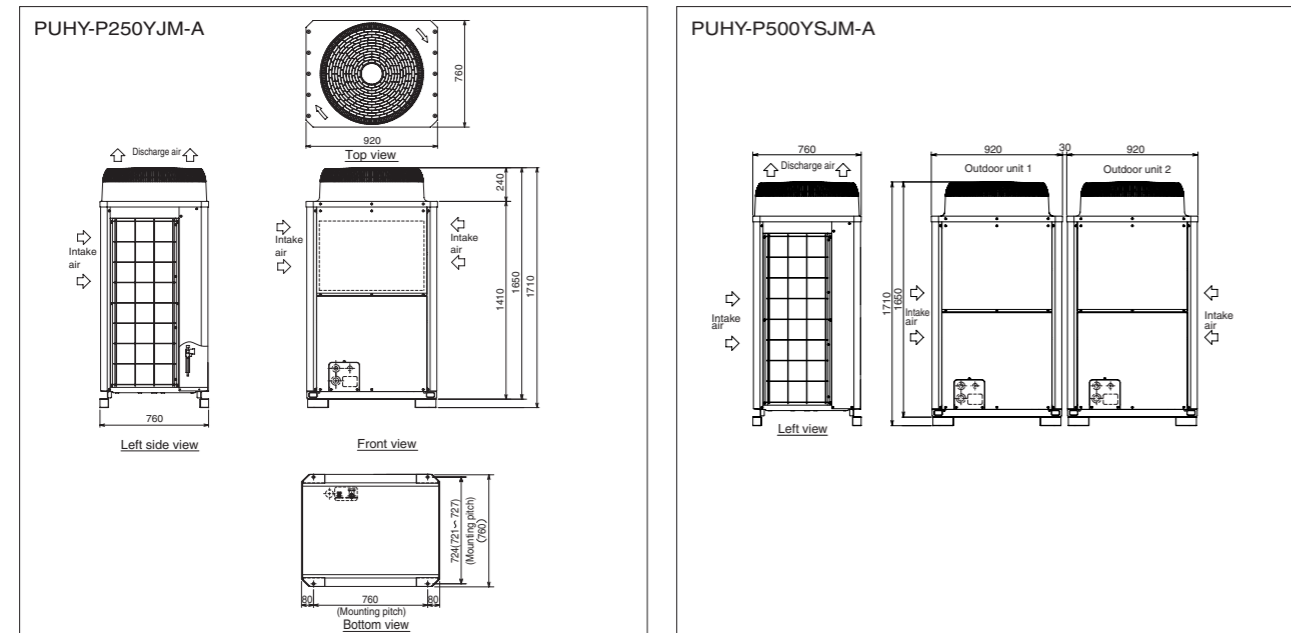

Heat Source Unit

PQHY-P250YHM-A
(connected with PFD series.)

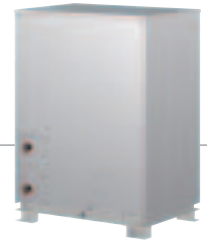

Specification

Model name		PQHY-P250YHM-A	
		Cooling	Heating
Capacity	kW	28.0	31.5
	BTU/h	95,500	107,500
Power source		3N~380 / 400 / 415V (50Hz / 60Hz)	
Power input	kW	5.45	5.51
Current	A	9.2 / 8.7 / 8.4	9.3 / 8.8 / 8.5
Compressor	Type	Inverter scroll hermetic compressor	
	Motor output	kW	
Heat exchanger	Type	plate	
	Water volume in the plate	ø	
Circulating water	Volume	m³/h	
		cfm	
	Pressure drop	kPa	
Refrigerant		R410A	
External finish		Acrylic painted steel plate	
External dimension (H) x (W) x (D)	mm	1160 (1100 without legs) x 880 x 550	
Protection device	High pressure protection	High pressure sensor, High pressure switch 4.15 MPa (601psi)	
	Compressor	Over-heat protection	
	Inverter	Over-heat protection, Over-current protection	
Refrigerant piping diameter	Liquid / Gas	ø 9.52 Brazed (ø 12.7 for over 90m) / ø 22.2 Brazed	
Sound pressure level	dB (A)	49	
Net weight	kg	195	
Operating temperature range	Water	10 ~ 45°C (50 ~ 113°F)	10 ~ 45°C (50 ~ 113°F)
	(Indoor)	(12 ~ 24°C (54 ~ 75°F) W.B.)	(15 ~ 28°C (59 ~ 82°F) D.B.)

- Note: 1. Cooling / Heating capacity indicates the maximum value at operation under the following condition.
 <Cooling> Indoor : 27°C (81°F) DB / 19°C (66°F) WB Water temperature : 30°C (86°F)
 <Heating> Indoor : 20°C (68°F) DB Water temperature : 20°C (68°F)
 Pipe length : 7.5m
 Level difference : 0m
 2. The ambient temperature of the heat source unit needs to be kept below 40°C (104°F) DB.
 3. The ambient relative humidity of the heat source unit needs to be kept below 80%.
 4. The heat source Unit should not be installed at outdoor.
 5. Be sure to mount a strainer (more than 50 meshes) at the water inlet piping of the unit.
 6. Be sure to provide interlocking for the unit operation and water circuit.
 7. It is measured in anechoic room.

External Dimensions

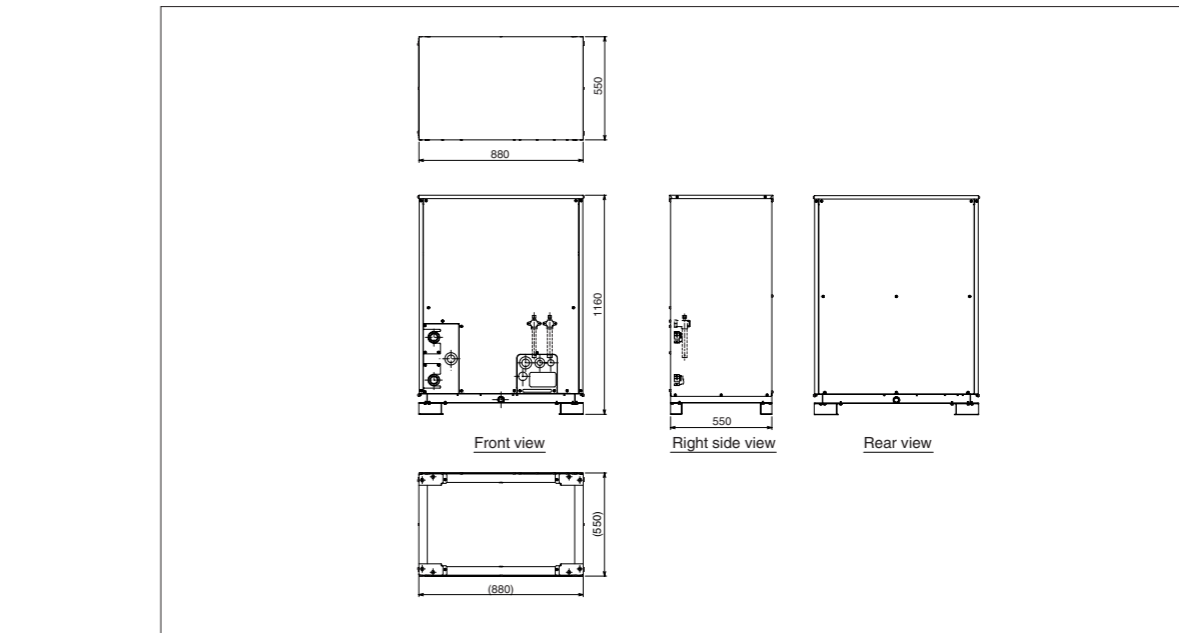



for a greener tomorrow

Eco Changes is the Mitsubishi Electric Group's environmental statement, and expresses the Group's stance on environmental management. Through a wide range of businesses, we are helping contribute to the realization of a sustainable society.



FM33568 / ISO 9001;2008

The Air Conditioning & Refrigeration Systems Works acquired ISO 9001 certification under Series 9000 of the International Standard Organization (ISO) based on a review of Quality management for the production of refrigeration and air conditioning equipment.

ISO Authorization System

The ISO 9000 series is a plant authorization system relating to quality management as stipulated by the ISO. ISO 9001 certifies quality management based on the "design, development, production, installation and auxiliary services" for products built at an authorized plant.



The Air Conditioning & Refrigeration Systems Works acquired environmental management system standard ISO 14001 certification.

The ISO 14000 series is a set of standards applying to environmental protection set by the International Standard Organization (ISO). Registered on March 10, 1998.

△ NOTICE

- When installing or relocating the air conditioners, use only the specified refrigerant (R410A) to charge the refrigerant lines. Do not mix any other refrigerant and do not allow air to remain the lines. If air is mixed with refrigerant, then it can be the cause of abnormal high pressure in the refrigerant lines, and may result in an explosion and other hazards. The use of any refrigerant other than that specified for the system will cause mechanical failure or system malfunction or unit breakdown. In the worse case, this could lead to a serious impediment to securing product safety. MITSUBISHI ELECTRIC CORPORATION cannot be held responsible for malfunctions or accidents resulting from the use of the wrong type of refrigerant.

MITSUBISHI ELECTRIC CORPORATION

<http://Global.MitsubishiElectric.com>